

. . - . , ,
-
-

XXXIX

2011

«...»

...

,

,

.

—

,

,

»

.

,

:

—

, QIC -

:

<http://www.airclima.ru/qic-conception.htm>



1.

—

.

2.

/

,

,

/

(

,

)

3.

(

,

,

,

)

4.

/

5.

) (, , - , ,)

6.

(« - , - ») , « » ,

7.

()

« « »

1. _____ :
« »

2. _____ :
» «



-

«

»

1.

(

,

)

2.

:

(

,

,

. .)

3.

(

,

,

,

,

)

4.

(, ,)

(, 1961)

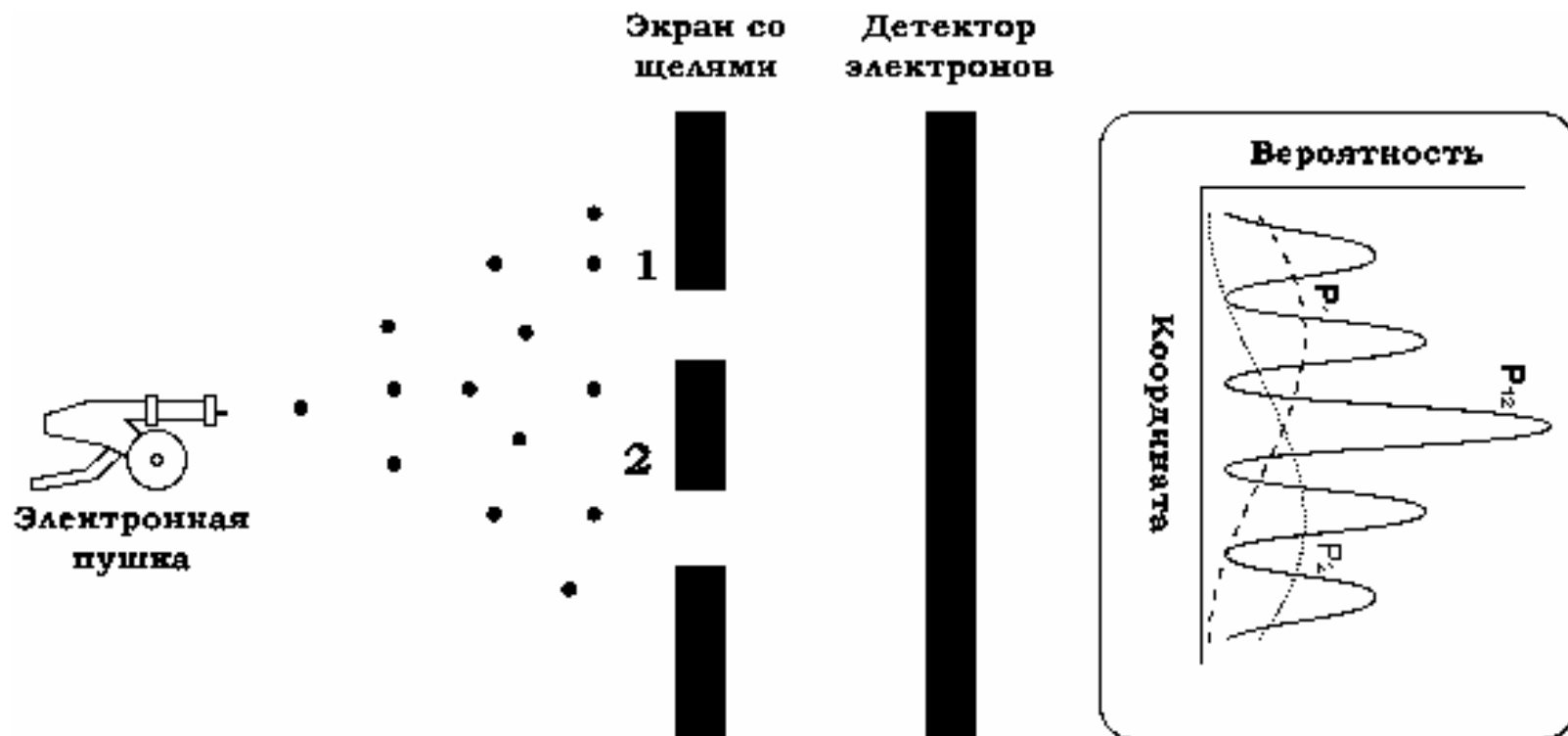

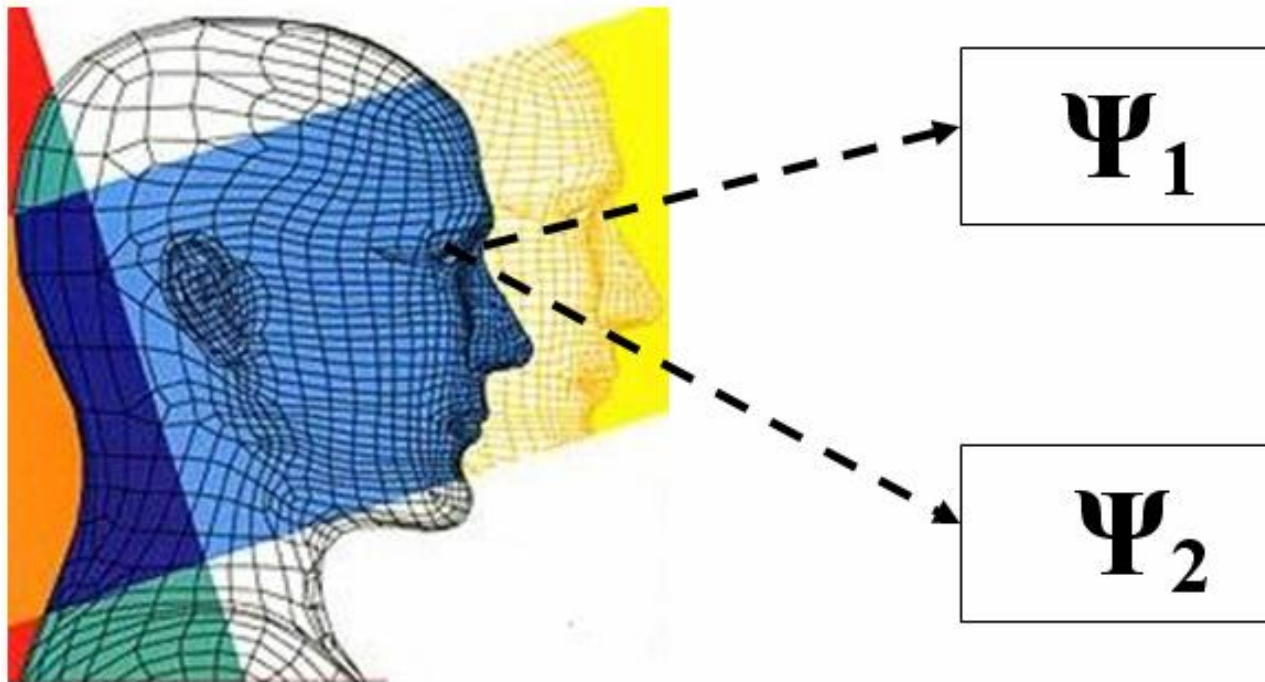

$$= C_1 \cdot \Psi_1 + C_2 \cdot \Psi_2, \quad |C_1|^2 + |C_2|^2 = 1, \quad |C_1|^2 = P_1, \quad |C_2|^2 = P_2$$

«

»

,

.

«

»

«

»

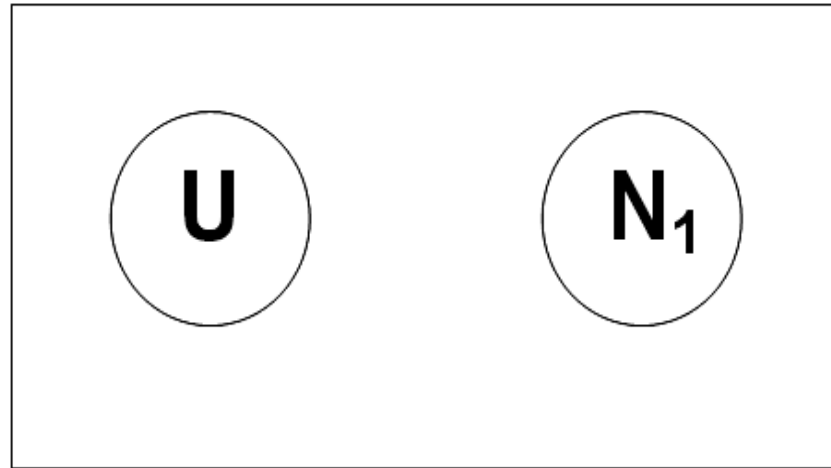
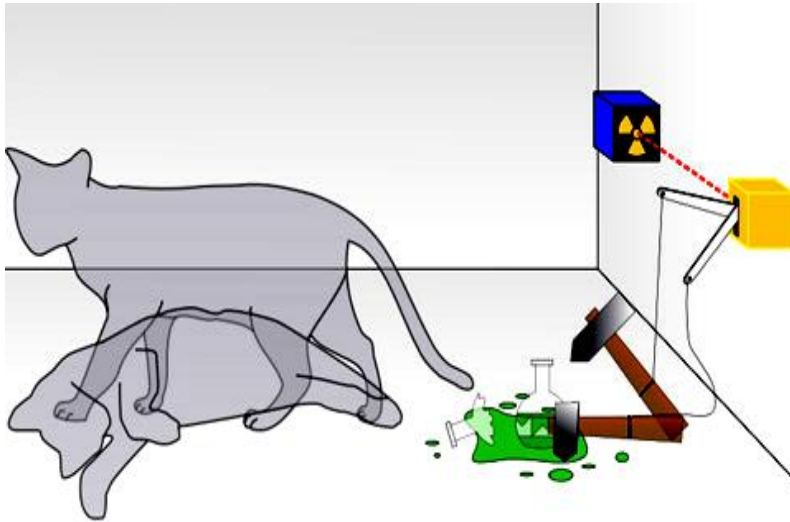

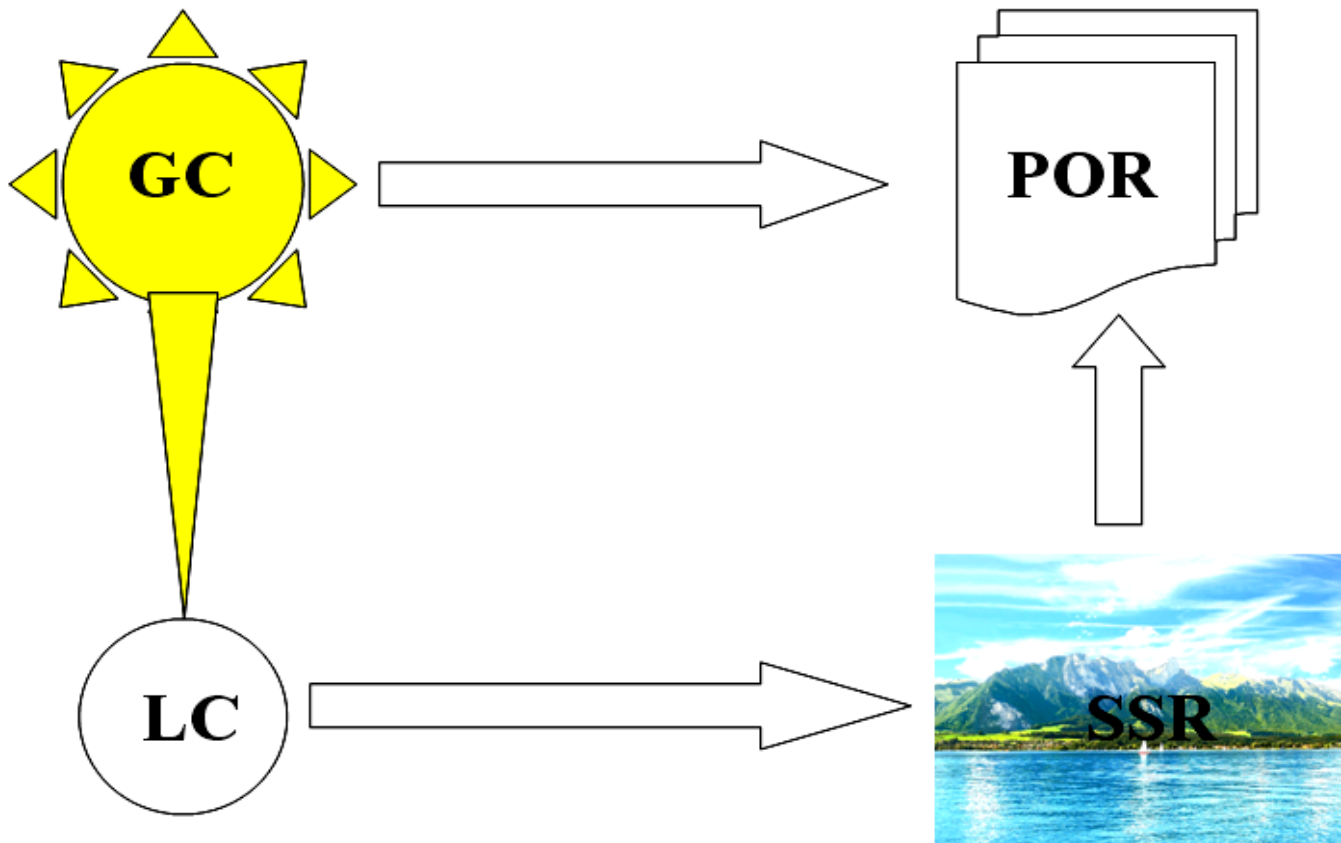

GC - (Global Consciousness)

LC - (Local Consciousness)

POR - ()

SSR - (Secondary Subjective Reality)

GC – POR –

« – »

LC = _____ (« _____ »).

– .

POR –

, ()

SSR –

, , « »

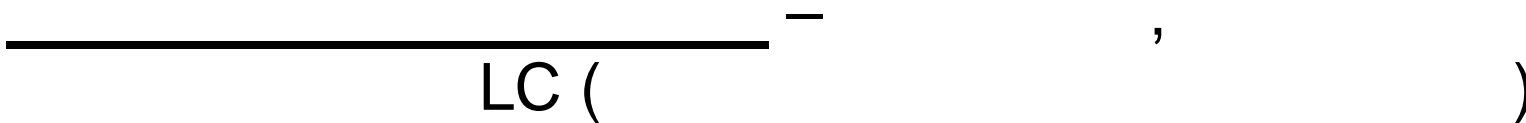
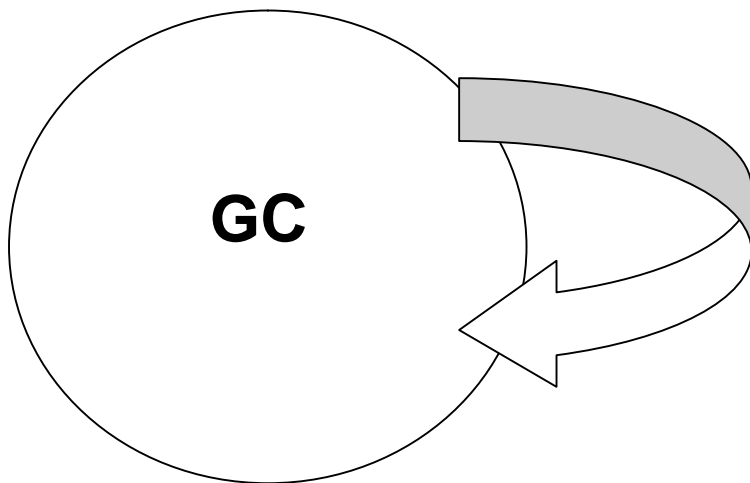

(SSR)

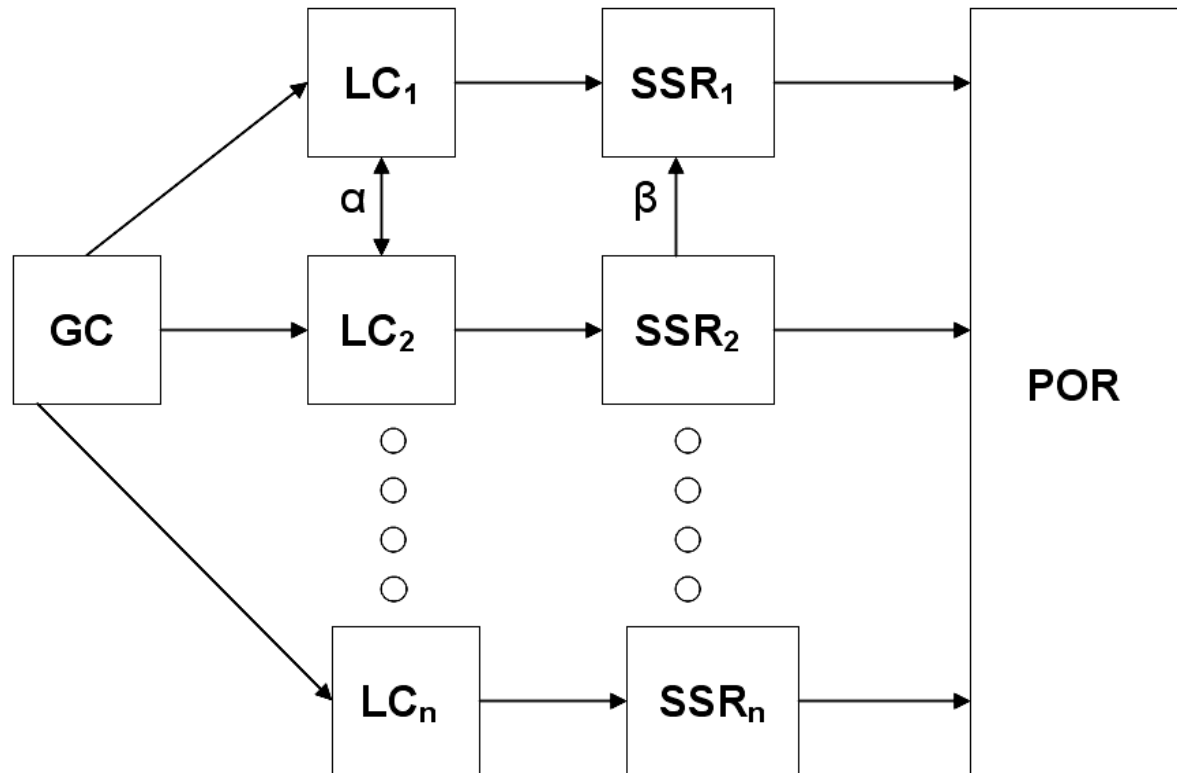

GC - $(LC_1, LC_2, \dots, LC_n)$, $SSR_1, SSR_2, \dots, SSR_n$ - $(LC_1, LC_2, \dots, LC_n)$, POR - $(LC_1, LC_2, \dots, LC_n)$

POR

.

1.

.

2.

«

»

.

3.

(

,

,

,

,

«

»)

4.

,

,

QIC -

«

»

1.

:

POR

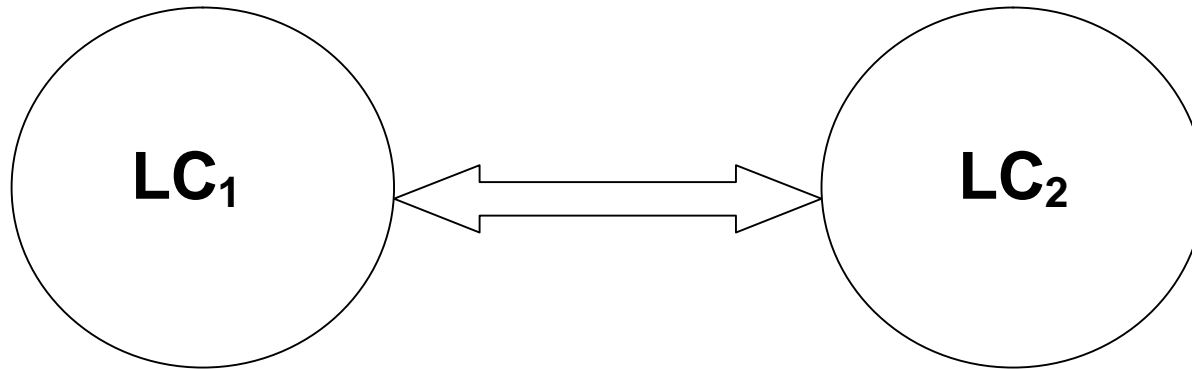

2.

,

«

-

»:

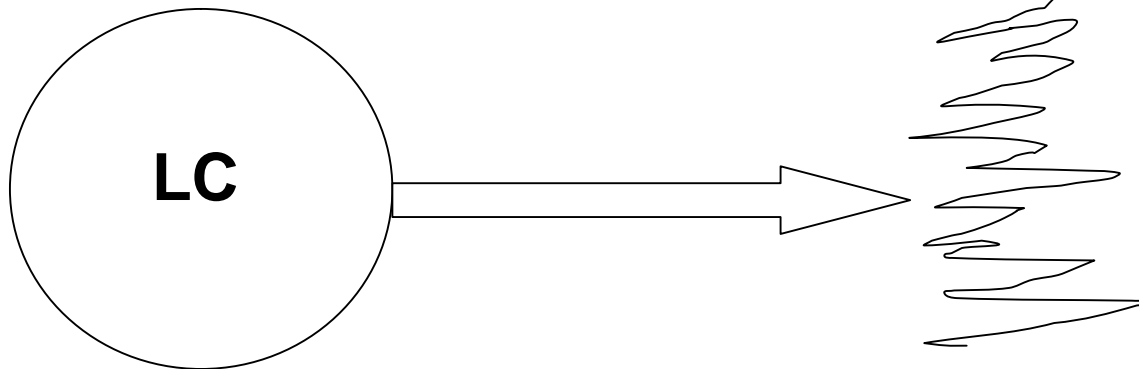

3.

, (:)

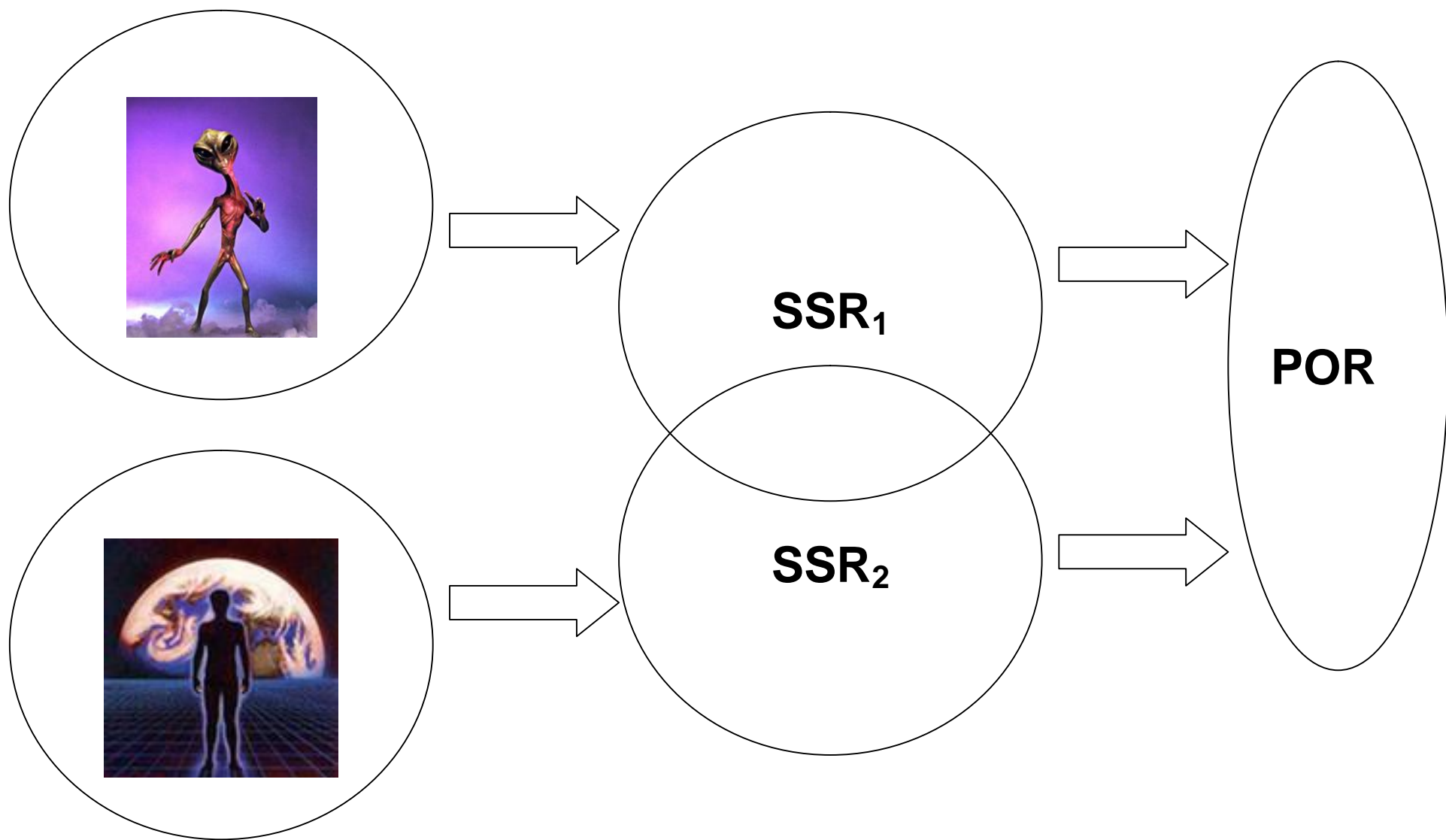

4.

(LC)

:

—

POR,

SSR (

)

«

» -

